



# **CONTENTS**

## **QUICK SETUP & INSTALLATION**

<b>FACTORY DEFAULTS .....</b>	<b>1</b>
<b>INSTALLATION OF THE SECURITY SYSTEM.....</b>	<b>2</b>
<b>COMMISSIONING THE DIALLER PANEL .....</b>	<b>5</b>
<b>ZONE INPUT CONNECTIONS.....</b>	<b>7</b>
<b>PANEL DIAGRAM.....</b>	<b>8</b>

## **USER MANUAL**

<b>THE SUPA8 KEYPAD .....</b>	<b>9</b>
SUPA8 INDICATOR LIGHTS.....	10
KEYPAD BEEPER OPERATION .....	10
KEYPAD LOCKOUT .....	11
KEYPAD ENTRY ERRORS .....	11
<b>SUPA8 OPERATION .....</b>	<b>12</b>
KEYPAD KEY FUNCTIONS.....	12
OPERATION OF ALL KEYS.....	12
<b>HOW TO TURN THE SYSTEM ON.....</b>	<b>17</b>
AWAY MODE (USING YOUR USER CODE).....	17
AWAY MODE (USING SUPER CODES) .....	19
HOME MODE (USING YOUR USER CODE).....	20
HOME MODE (USING QUICK HOME).....	20
<b>HOW TO TURN THE SYSTEM OFF .....</b>	<b>21</b>
<b>ISOLATING ZONES.....</b>	<b>21</b>
<b>PROGRAMMING USER CODES .....</b>	<b>22</b>
<b>PERSONAL REPORTING .....</b>	<b>23</b>
<b>PROGRAMMING TELEPHONE NUMBERS.....</b>	<b>24</b>
<b>OPERATION BY TELEPHONE.....</b>	<b>25</b>
<b>FREQUENTLY ASKED QUESTIONS .....</b>	<b>26</b>
<b>SYSTEM RECORD SHEET .....</b>	<b>278</b>

---

## Quick Setup & Installation

Thank you for purchasing the SUPA8 Security Alarm System, the following is intended to assist you in the installation of the system. **Please read these guidelines before installation.**

**Note:** *In some States of Australia special licensing may be required in order to install Security Alarms and Associated Equipment. Please check with your local State Authority for details before commencing installation work.*

### **IMPORTANT:**

This section is a brief outline of installation and programming. For additional information refer to the SUPA8 Installer Manual.

## **Factory Defaults**

THE SUPA8 ALARM SYSTEM COMES FROM THE FACTORY PROGRAMMED AND READY TO GO. BEFORE MAKING ANY CHANGES, CHECK WHAT IS ALREADY PROGRAMMED, AS THEY WILL MOST PROBABLY SUIT YOUR NEEDS.

<b>MASTER USER CODE</b>	<b>: 1 2 3 4</b>
<b>INSTALLER CODE</b>	<b>: 2 5 8 0</b>
<b>ENTRY TIME</b>	<b>: 30 seconds</b>
<b>EXIT TIME</b>	<b>: 60 seconds</b>
<b>SIREN TIME</b>	<b>: 5 minutes</b>
<b>ZONE TYPE</b>	<b>Zone 1 : Entry Delay</b> - enables entry exit timer.
	<b>Zone 2 : Handover</b> - enables exit timer and entry timer if Entry Delay Zone entered first.
	<b>Zone 3 : Handover</b> - enables exit timer and entry timer if Entry Delay Zone entered first.
	<b>Zone 4 : Instant</b> - immediately sounds siren if violated when system is armed.
	<b>Zone 5 : Instant</b> - immediately sounds siren if violated when system is armed.
	<b>Zone 6 : Instant</b> - immediately sounds siren if violated when system is armed.
	<b>Zone 7 : 24 Hour</b> - sounds sirens if violated whether system is armed or disarmed.
	<b>Zone 8 : 24 Hour</b> - sounds sirens if violated whether system is armed or disarmed.

**NOTE:** When Armed in Home Mode Zones 5 and 6 has been programmed to be isolated.

## Installation of the Security System

### *Step 1:*

Plan out location of all components supplied in your kit as follows:

### Suggested Locations for Equipment Mounting

- (a) The 8 Zone Master Panel Box should always be located out of sight (i.e. cupboard, wardrobe or in an area it would not be easily seen).
- (b) The 8 Zone Keypad should be situated near the main entry/exit point (usually inside the main front door).
- (c) The External Siren (enclosed in siren cover along with Tamper Button) should be mounted in a prominent position in full view. This would normally be mounted under the eaves at the front of the house in a corner position. The strobe light is mounted onto the siren cover.
- (d) The Flush Mount Reed Switches are most suitable to be mounted on the front and back doors.
- (e) The Passive Infra Red Detectors (PIR'S) should be situated to cover high access areas (eg: Hallways and areas of high importance or value).
- (f) The Emergency Button should be located in a position for quick easy access in an emergency or panic situation (suitable position could be a bedside location).
- (g) The Pinkerton Security Alarm Warning Stickers should be placed on the front face of the Siren cover and on an outside window in clear view.

*Note: PIR's are susceptible to environmental conditions such as wind and air movement. Windows must be closed when system is armed to avoid possible false alarms.*

### *Step 2:*

- (a) Install all cabling to component positions.
- (b) **Austel approved** cables must be installed if the system is to be monitored. Use two pair (4 core) 14/0.20 and Figure 8 (2 core) 14/0.20.

**REMEMBER TO MARK YOUR CABLES.**

---

***Step 3:***

- (a) Mount devices in the most suitable locations (as suggested in Step 1).
- (b) Wire cabling directly into devices.
- (c) At this point install the 4.7K End of the Line (EOL) Resistor.  
(Refer to Page 7).

The feature of this resistor is that when installed at the furthest point in the Zone, tampering or interference with the wiring is not possible without setting off the alarm.

*Note: All joints connecting cables to EOL Resistors must be soldered and taped.*

***Step 4:***

- (a) Install Master Control Panel and connect all cabling to panel.
- (b) A 240V GPO is required adjacent to the Master Control Panel position for the Plug Pack.

***Step 5:***

Seal any unused or spare Zones with a 4.7K (EOL) end of line resistor.

***Step 6:***

Connect Battery, now Switch on Plug Pack supply.

*Note: Once the alarm system is powered up, control of the system is handed over, and managed by the 8 Zone Keypad. All programming for the system is done via the Keypad.*

***Step 7:***

Upon power up the Zone 3 LED will be on, and the ON-LINE LED will also be on indicating a system self test.

After the alarm panel has initiated this tests the panel will go into alarm **if** Zones 7 & 8 (24 hour Zones) are not sealed.

**To DISARM the panel:**

- (a) **On Keypad**  
Enter:  (all Zone lights will flash)
- (b) **Followed by:**  (the off key)

**Step 8: Walk Test**

To check operation of all Zones a Walk Test is recommended.

- (a) **On Keypad**  
Enter:  (all Zone lights will flash)
- (b) **Followed by:**  (to initiate a walk test)

**The walk test function is now activated.**

The Zone LED will light as each Zone is triggered and the siren will squawk momentarily. The Zone LEDs will remain on to show which Zone has been violated. (Requires only one person testing).

To deactivate a walk test press the  key.

**THE SYSTEM IS NOW OPERATIONAL**

To arm and disarm the system enter Master User Code  (factory default) followed by

**To arm the system enter:**  (ON)

**To disarm the system enter:**  (OFF)

*Note:* The system can also be quick armed by pressing

To disarm enter User Code then

To change Master User Code or User Codes, please refer to Page 22

**This completes the instruction for a Local Panel**

## Commissioning the Dialler Panel

### Austel Requirements:

Austel requirement's state that all Dialler Panels connected to the Telephone Network must have the Telephone connection and termination work performed and completed by a current Austel Licence Holder.

### **To Assign for Local Dialling (to a nominated telephone number) for Self Monitoring Purposes.**

#### **Step 1:**      On Keypad

Enter programming mode:

**You are now in Programming Mode (ON-LINE light will flash).**

#### **Step 2:**      On Keypad

To set up Personal Reporting format:

Enter:       (address number)

Followed by:       (cancels the programming mode)

#### **Step 3:**      On Keypad

Re-enter programming mode:

Enter:

#### **Step 4:**      On Keypad

Entering of required telephone number/s.

1<sup>st</sup> Telephone Enter:            

2<sup>nd</sup> Telephone Enter:            

**Note:**      (a) The above numbers are **examples only**. You must enter the correct numbers to dial according to the Home owner's requirements. A maximum of two telephone numbers can be programmed.

              (b) The phone numbers can consist of a mix of mobile phones numbers and local phone numbers. Only one phone number can be programmed if required.

              (c)  is used to finish the phone number.

              (d)  completes address (allows next address).

#### **Step 5:**      On Keypad

Exit programming:                      Enter:



## System is now operational as a Self Monitored Dialler.

*Note: In the event of an alarm, the dialler will emit via the telephone system, a computer generated siren tone.*

*If you are installing a Dialler Panel and do not wish to connect to a telephone line, you MUST default the panel to a local format. (See page 7 of Installer Manual)*

### To Assign for Pinkerton Security Central Monitoring Station Dialling.

There are two formats that can be selected for central station monitoring; domestic monitoring and business monitoring. The difference between domestic and business monitoring is that business monitoring will send opening and closing reports.

Before commencing programming please contact Pinkerton Monitoring Pty Ltd on (03) 9888 9889 for allocation of Dialler Telephone Numbers and Client Identification Number.

#### **Step 1: On Keypad**

To enter programming mode.

Enter:

**You are now in Programming Mode (ON-LINE light will flash).**

Enter:  (for domestic monitoring)

**or**

(for business monitoring)

#### **Step 2: On Keypad**

Re-enter programming mode:

Enter:

#### **Step 3: On Keypad**

To program Central Monitoring Station Telephone Number:

Enter:

Enter:

*Note:*

- (a) The above number **03 91234567** is an example only.
- (b) If you are only supplied with one central station number please enter that number into both telephone addresses.
- (c)  is used to finish the phone number.
- (d)  completes address (allows next address).

**Step 4: On Keypad**

To assign Client Identification Account Number (example No:1111).

Enter:      

Enter:      

**Note:**    **The Account Number must be programmed into both addresses.**

**The above Account Number is allocated by your Central Monitoring Station.**

Enter:     (to exit programming mode).

**This system is now operational as a Central Monitoring Station Dialler.**

## Zone Input Connections

General Examples Only. Refer to installation guidelines supplied with device.

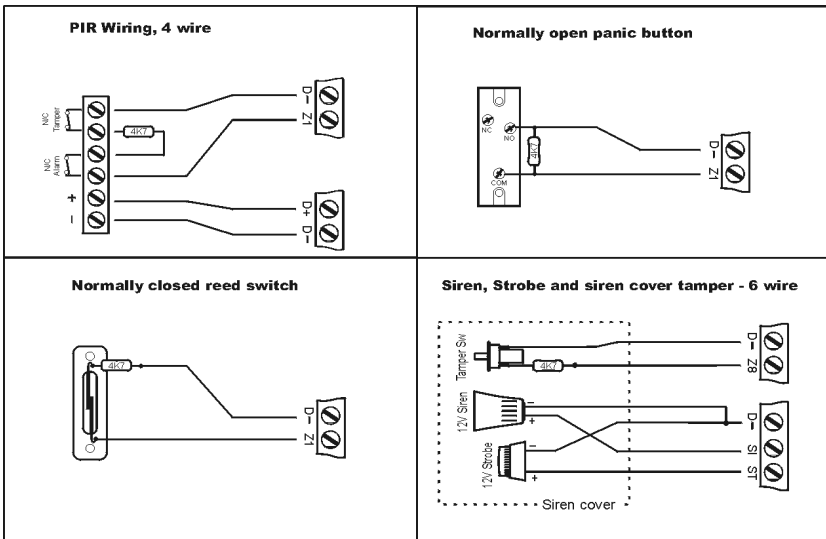

## Panel Diagram

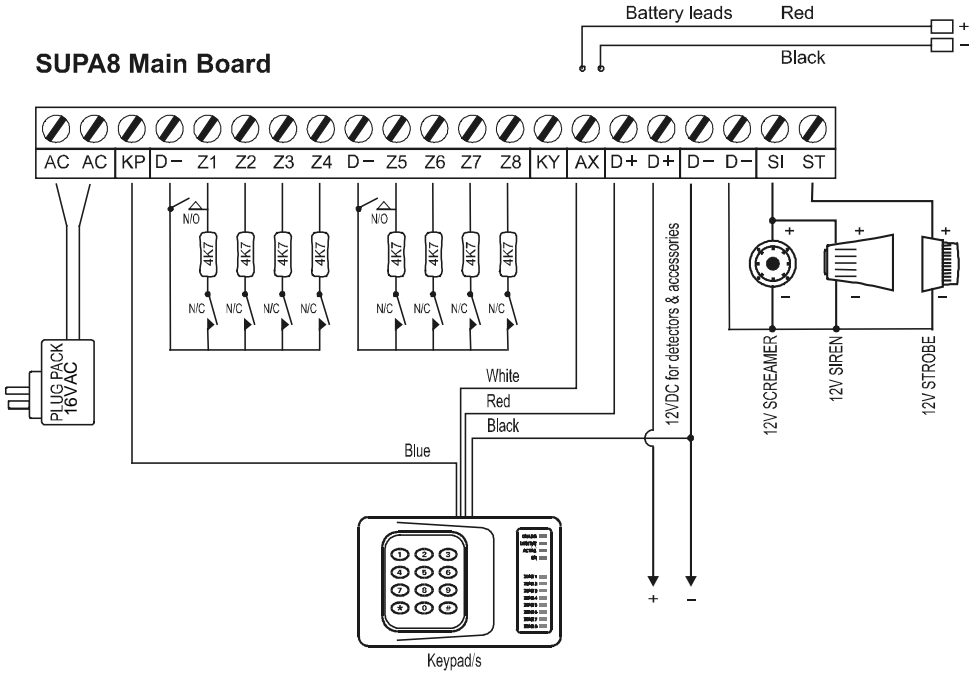

*User Manual*

## The SUPA8 Keypad

The SUPA8 Keypad controls the operation of the SUPA8 alarm panel. It uses a series of command entry keys to input codes that can arm, disarm and program the system. The soft-touch rubber keypad is concealed behind a hinged lid and a series of System and Zone lights run down the right-hand side of the fascia.



## SUPA8 Indicator Lights

Listed below are the use of the indicator lights when in normal operation.

Keypad Light	Light ON	Light OFF	Light Flashing
<b>On-Line</b>	Dialler on line	Dialler not on line	Dialler had problems
<b>Low Batt</b>	Battery Charge Voltage Low	Battery OK	Had Low Batt alarm
<b>AC Fail</b>	Power not connected	Power OK	Had AC fail alarm
<b>On</b>	SUPA8 is ON (Away mode)	SUPA8 is OFF	SUPA8 is ON (Home mode)
<b>Zone 1 - 8</b>	Unsealed, Manual or Auto isolated	Zone is sealed	Had alarm

Note that the status of the Zones will always be displayed unless disabled by the installer. The Low Batt and AC Fail lights will show the current state of these inputs, however the alarm (or restore) condition may have to be present for a period before a report is initiated.

If the dialler fails to communicate, the On-Line light will remain flashing until the next time the system is turned OFF.

### All Zone lights on plus a continuous beeper

Means the keypad is locked out for 60 seconds caused by 4 consecutive incorrect code entries.

### All Zone lights flashing

Indicates a legal code has been entered (or the  key pressed) and the SUPA8 expects another key to be pressed to select the desired function within 10 seconds.

To cancel simply wait 10 seconds or press the  key.

## Keypad Beeper Operation

The keypad beeper will sound under the following circumstances:

---

Any key press	short beep
Turn SUPA8 OFF	short beep
Turn SUPA8 ON (only heard if exit beep is disabled)	2 short beeps
Display of new data in programming mode	2 short beeps
Wrong key or illegal action	long beep
Press  key	long beep
In Home Mode when a Home Beep Zone is triggered	short beep
Keypad lockout due to too many code entry attempts	continuous beep
During exit delay if Exit Beep is enabled	continuous beep
At end of exit delay if Exit Beep is disabled	3 short beeps
During entry delay if Entry Beep is enabled	continuous beep

## Keypad Lockout

If an incorrect code is entered 4 times then the keypad will be locked out for 60 seconds. During this time the Zone lights will be on and the beeper will sound continuously.

## Keypad Entry Errors

When an error is made in entering digits, the keypad will emit a long beep and resume idle mode. Just prior to the beep the Zone lights will display the type of error that was detected:

Light ON	Error type
1	 key pressed.
2	No matching code was found.
3	Keypad timeout has occurred.
4	Illegal key in current mode.
5	Illegal mode (either SUPA8 is ON or not in exit delay).
6	Action prevented by a programming option.
7	Address/Action is illegal for this code.

# SUPA8 Operation

## Keypad Key Functions

After a code is entered or the  key is pressed, you have 10 seconds to select the operation you wish to perform. During this time all 8 Zone lights will flash to indicate that a key should be pressed. If no key is pressed within 10 seconds, the keypad will revert to idle mode. Enter your code to start again.



The  key is always used as the "clear key" to abort the current operation.



## Operation of all keys



### PANIC

#### Key

Enter a User Code followed by  or enter   to trigger the Panic function. The Panic function can trigger the siren or strobe light or dialler as programmed by your installer.



### DURESS

#### Key

Enter a User Code followed by  or enter   to trigger the Duress function. The Duress function can trigger the siren or strobe light or dialler as programmed by your installer.

### TEST

#### Key

Enter a User Code followed by  or enter   to trigger the Test function. The Test function is used to test the dialler by sending a test transmission to the programmed telephone numbers. This function is only available if your system is programmed to report alarms to a monitoring station.

## REVIEW

Key **4**

Enter a user code followed by **4** or simply enter **# 4** to enter review mode. The ON-LINE, LOW BATT, AC FAIL & ON lights will all be on to indicate you are in review mode. Review mode displays a history of past alarms and events stored in the SUPA8's memory.

This alarm memory is permanently stored and can be cleared by pressing the **0** key while in review mode.

(Please note that your Entry Delay Zone/s will always be stored in memory, even if they have not alarmed.)

While in review mode, various events will be displayed by pressing the following keys:

- Key **1** Displays past Zone alarms since the last reset.
- Key **2** Displays past alarms other than Zones.
- Key **3** Display previous events (miscellaneous).
- Key **0** Clear review memories.
- Key **9** Displays the SUPA8's software version. (in binary).
- Key **\*** Exit review mode.

When first entered, review shows past Zone alarms. The following tables show how to interpret the various displays:

### REVIEW **1**

#### Previous Zone Alarms

While in REVIEW mode, pressing Key **1** displays:

**Zone**

**Light    Meaning**

1 - 8    Previous alarm on Zones 1 - 8 since the SUPA8's last reset.

*Note: The first Zone that was triggered will be flashing.*

## REVIEW 2

### Previous Non-Zone Alarms

While in REVIEW mode, pressing Key 2 displays:

**Zone**

**Light    Meaning**

- |   |                                      |
|---|--------------------------------------|
| 1 | Duress input triggered.              |
| 2 | Panic input triggered.               |
| 3 | Test input triggered.                |
| 4 | Low Battery input triggered.         |
| 5 | AC Fail input triggered.             |
| 6 | On input triggered.                  |
| 7 | Fail-to-communicate input triggered. |
| 8 | Spare input triggered.               |

## REVIEW 3

### Previous Events (Miscellaneous)

While in REVIEW mode, pressing Key 3 displays:

**Zone**

**Light    Meaning**

- |   |  |
|---|--|
| 1 | Siren has been turned on.                      |
| 2 | Strobe has been turned on.                     |
| 3 | Dialler has been triggered.                    |
| 4 | Dialler failed (reached max. attempts).        |
| 5 | (Not used)                                     |
| 6 | Maximum code attempts activated.               |
| 7 | Low battery has turned off siren (and strobe). |
| 8 | Answered phone.                                |

## WALK TEST

### Key

Selecting this operation whilst the SUPA8 is OFF will initiate walk-test mode. Walk-test can only be performed by holders of user codes 1 to 7. Walk-test mode allows all Zones, the siren and the strobe to be tested. Operation is as follows:

When walk-test mode is first entered, all 8 Zone lights will be off. The AC Fail light will show whether AC is present or not and the Low Batt light will show whether the battery charging voltage is adequate.

As Zones are triggered the siren will squawk and the relevant Zone light will turn on and remain turned on. This allows a "one man" walk-test by walking through all Zones.

Pressing the  key turns off all Zone lights and allows the test to be repeated, if required.

## SIREN AND STROBE TEST.

While in test mode:

Pressing the  key will turn on the siren.

Pressing the  key will turn on the strobe.

*This enables you to check the individual operation of the siren and strobe.*

Pressing the  key will turn off the siren and strobe.



Press the  key to exit walk-test.

## ISOLATE

### Key

This operation allows Zones 1 - 8 to be manually isolated or re-enabled at any time and is only available to holders of user codes 0 to 7. The ON-LINE, LOW BATT, AC FAIL and ON lights will illuminate and the Zone lights will show the current manual isolate status of the Zones.

A Zone light being ON, means that Zone is manually isolated.

As keys  to  are pressed, the relevant Zone light will toggle on or off. When the light is on the Zone is isolated.

The  key is used to exit out of isolate mode (isolate mode will also end if there are no keys pressed for 10 seconds).

Note that isolated Zones only remain isolated until the next time the SUPA8 is turned OFF, even if the SUPA8 is already OFF. AC fail, Low battery, Panic, Test and Duress inputs cannot be isolated.

*See page 13 for examples.*



## PROGRAM

### Key

Enter installer or master code followed by  to enter programming mode. Only available to the master code and the installer code.

## ON (HOME MODE)

### Key

Enter any user code followed by  or enter   to turn the SUPA8 ON in Home Mode. ON light will flash to indicate SUPA8 is armed in home mode. Only Zones which are programmed as Home Zones will be active.

## ON (AWAY MODE)

Key

Enter any user code followed by  or enter   to turn the SUPA8 ON in Away Mode. ON light will turn on to indicate SUPA8 is armed in Away Mode. Only Zones which are programmed as Away Zones will be active. All user codes are allowed to arm the SUPA8.

## OFF (DISARM)

Key

Enter any code followed by  to turn the SUPA8 OFF. Turning the SUPA8 OFF will also turn the sirens and strobe off and re-enable manually isolated Zones even if the SUPA8 is already OFF.

## How to turn the system ON.

### AWAY mode (using your User Code)

In the AWAY mode, all Zones programmed as AWAY Zones will be armed. (Typically this means all Zones.)

The ON light should be off indicating the system is OFF.

Make sure that all protected doors and windows are shut securely. Check also that all Zone lights on the Keypad are off, except for the Zones you use to exit the premises. (Check that no pets are left to roam inside the protected areas - curious cats and dogs are a major cause of false alarms).



1. Enter  ..... To clear the keypad
2. Enter  .... Your User Code  
(All Zone lights will flash - waiting for a command)
3. Enter  ..... Arms the SUPA8 in Away mode
4. Check that the ON light turns on.  
(The exit beeper will sound continuously during exit delay. If the exit beeper has been turned off by the installer, three beeps will be heard at the end of exit delay.)

You now have a limited time to leave the premises (which will have been preset by your installer) before an alarm is generated. If you need to re-enter the premises, turn the system OFF, then back ON again as you leave.

NOTE: If you make a mistake when you attempt to enter your User code, press the  key and try again.

### **AWAY mode (using Quick Away)**

Your installer may have programmed the SUPA8 to allow abbreviated arming. If so, turn the system ON as follows.

1. Enter  ..... To clear the keypad
2. Enter  ..... (All Zone lights will flash - waiting for a command)
3. Enter  ..... Arms the SUPA8 Away mode
4. Check that the ON light turns on.  
(The exit beeper will sound continuously during exit delay. If the exit beeper has been turned off by the installer, three beeps will be heard at the end of exit delay.)

## AWAY mode (using Super Codes)

### WHAT ARE SUPER CODES?

The Super Codes option allows the Master Code holder to issue user codes with limited functions to some users of the SUPA8.

### SUPER CODE OPERATION

If your installer has enabled the Super Codes option, User Codes will operate as follows:

Master User Code and User Codes 2 to 7 operate normally (as per page 9).

Enter USER CODE then  to turn SUPA8 ON.

Enter USER CODE then  to turn SUPA8 OFF.

Or Enter USER CODE then [any digit] for access to all allowable functions.

User Codes 8 to 15 operate as below and can only turn the SUPA8 ON and OFF.

Enter USER CODE to turn SUPA8 ON.

Enter USER CODE to turn SUPA8 OFF.

### PURPOSE OF SUPER CODES

The Super Codes option was introduced for two reasons.

Some users prefer the option of simply entering their four digit user code to turn ON or OFF without the requirement to enter the fifth, command digit.

If you have multiple users each with their own user code, you may not want to allow all the users to have access to other SUPA8 functions such as Review Memory, Isolation, Walk Test, etc. These users should be allocated a user code from 8 to 15.



Holders of codes 8 to 15 still have access to the keypad Panic facility by pressing

## HOME mode (using your User Code)

The ON light should be off indicating the system is OFF.



Your installer may have installed your system so that some areas may be monitored whilst you are still on the premises. For example, the doors and windows may be protected at night leaving the internal detectors isolated to allow movement inside the house.

Make sure that all protected areas are shut securely.

1. Enter  ..... To clear the keypad
2. Enter  .... Your User Code  
(All Zone lights will flash - waiting for a command)
3. Enter  ..... Arms the SUPA8 in Home mode
4. Check that the ON light starts flashing to indicate arming in Home mode.  
(The exit beeper will sound continuously during exit delay. If the exit beeper has been turned off by the installer, three beeps will be heard at the end of exit delay.)





## HOME mode (using Quick Home)

Your installer may have programmed the SUPA8 to allow abbreviated arming. If so, turn the system ON as follows.

1. Enter  ..... To clear the keypad
2. Enter  ..... (All Zone lights will flash - waiting for a command)
3. Enter  ..... Arms the SUPA8 in Home mode
4. Check that the ON light turns starts flashing to indicate arming in Home mode.  
(The exit beeper will sound continuously during exit delay. If the exit beeper has been turned off by the installer, three beeps will be heard at the end of exit delay.)









## How to turn the system OFF

The ON light will be on or flashing.

1. Enter     .... Your User Code  
(All Zone lights will flash - waiting for a command)
2. Enter  ..... Turns OFF the SUPA8
3. Check that the ON light turns off.

## Isolating Zones

You are able to isolate (disable) selected Zones and turn the system ON. This is useful in cases where, for example, a pet will be kept in a certain room or if a detector has become faulty and must be isolated from the system.







1. Enter  ..... To clear the keypad
2. Enter     .... Your User Code  
(All Zone lights will flash - waiting for a command)
3. Enter  ..... The ON-LINE, LOW BAT, AC FAIL & ON lights will turn on to indicate isolation mode.
4.  ..... Enter the Zone number/s you wish to isolate. The corresponding lights will turn on. Pressing the Zone number again will turn off the isolation for that Zone.
5. Enter  ..... To exit isolation mode

The system can now be turned ON as normal. Isolated Zones are enabled again the next time you turn the SUPA8 OFF.

## Programming User Codes

Use the Master User Code to enter and delete user codes as follows. The Master User Code can re-program other codes as well as turning the SUPA8 ON and OFF.

There are 14 user codes plus the Master User Code. All codes are four digits in length. Do not program two codes identically. If two codes are the same, only the lower numbered code will be active. (For example, if user code 3 and 9 are both programmed as 1234, the SUPA8 will only recognise user code 3).

1.  ..... Your Master User Code  
(All Zone lights will flash - waiting for a command)
2.  ..... To enter program mode  
(ON-LINE lights flashing indicates program mode)
3.  ..... Address for the User Code  
See the table of addresses on page 20.  
(The existing User Code, if any, will be displayed digit by digit.  
If the User Code you are programming is currently blank, lights 7 & 8 will be on.)
4.  ..... Enter a four digit code  
Enter each digit slowly and wait for the keypad to beep after each digit is entered. The ON-LINE light will be flashing if all digits have been entered correctly.  
  
(If you make a mistake at this stage, press  to go back to step 3)
5.  ..... To exit program mode

## Personal Reporting

Personal reporting allows dialler reports to be sent to a person rather than a central station if an alarm occurs. When an alarm occurs, the SUPA8 will automatically seize the telephone line and dial a pre-programmed phone number. The SUPA8 will then output an alternating high/low siren sound to indicate that an alarm has occurred.

Rather than sending the audible siren tone, the SUPA8 can be programmed to send beeps down the line to identify the Zone causing the alarm. The number of beeps equal to the Zone number that was triggered.

Every 10 seconds the tones will pause, allowing any key to be pushed to acknowledge the call and cause the SUPA8 to announce the current state of the system; 1 beep if OFF, 2 beeps if ON. The  key may now be used to hang-up the SUPA8 immediately or it will hang-up automatically after 15 seconds. Before hanging up, the SUPA8 can be turned ON or OFF, see page 17.

If after one minute no key has been pressed, the SUPA8 will hang up and try again.

During reporting in personal format mode, prior to a key being pushed by the answering party, the report may be aborted by entering any valid user code on the SUPA8 keypad. Note that once the called party has pushed a key, the SUPA8 keypad lights will flash indicating that the called party is now in control.

A special temporary telephone number can be programmed by the Master User Code to replace the primary telephone number. When programmed, this number will replace the primary telephone number until the SUPA8 is next turned OFF from away mode, at which time the first digit of the temporary number is erased (disabling the temporary number) and operation will revert to the primary telephone number.

## Programming Telephone Numbers

*Note: To be able to program telephone numbers the SUPA8 must be programmed for personal dialling format.*

Telephone numbers are programmed at specific addresses in the system memory.

Addresses are:      Telephone Number 1    **128**  
                                 Telephone Number 2    **144**  
                                 Temporary Telephone    **112**

### Programming Telephone number 1

1.     ..... Your Master Code  
(All Zone lights will flash - waiting for a command)
2.  ..... To enter program mode  
(ON-LINE lights flashing indicates program mode)
3.    ..... Address for Telephone number 1  
(The existing telephone number, if any, will be displayed digit by digit)
4.          ..... Enter the Telephone number  
(Maximum 15 digits)  
(If you make a mistake at this stage, press \* to go back to step 3)
5. #  ..... Must be entered after the number
6. \* ..... To finish current address

At this stage you can enter the address of another telephone number by repeating steps 3 to 6 or press \* to exit program mode.





*Note: The maximum length of any telephone number is 15 digits.*

## Operation by Telephone

Your SUPA8 alarm panel may have been set up to allow you to telephone the system to determine if it is ON or OFF. You can also turn the system ON or OFF remotely by telephone. The call can be made from any telephone capable of tone dialling, including DTMF-capable mobile telephones. To operate your system by a telephone call, follow the steps below:

1. Ring the number that your SUPA8 is connected to. In most cases that will be your home telephone number.
2. After 15 rings, or the programmed number of rings, the SUPA8 will answer the phone. If the SUPA8 is OFF only one beep will be heard.

If the call is cut off before 15 rings (either because the telephone network will not allow 15 rings or an answering machine is connected and keeps intercepting the call), immediately hang up and call the system back. It remembers the number of rings for 45 seconds after a call attempt has been terminated. It will continue to count rings through repeated attempts until either 15 rings have occurred or more than 45 seconds has elapsed without a ring. (If you only want to check the ON/OFF status of the SUPA8, without making any change, simply hang up after you hear the beep or beeps.)

3. If you want to turn the SUPA8 ON, enter your 4 digit user code followed by the  key on your telephone keypad. If you make a mistake then press the  key and try again.
4. If you want to turn the SUPA8 OFF, enter your 4 digit user code followed by the  key on your telephone keypad. If you make a mistake then press the  key and try again.
5. The  key may now be used to hang-up the SUPA8.

**NOTE:** If the SUPA8 needs to ring the monitoring station as a result of turning ON or OFF the panel then you should hang-up immediately to allow the call to proceed.

## Frequently Asked Questions

### General Questions

**Q Can an alarm be caused when the system is OFF?**

A Yes. Some Zones may have been programmed to be on all the time. These are termed “24 Hour Zones”. If a 24 Hour Zone causes an alarm when the SUPA8 is OFF, just turn the SUPA8 OFF using your user code and the  key.

**Q How can I tell the system is ON, OFF or in HOME mode?**

A By looking at the ON light you can tell whether the SUPA8 is ON or OFF. If the ON light is on then the SUPA8 is on in AWAY mode. If the ON light is flashing then the SUPA8 is on in HOME mode. If the light is off then the SUPA8 is OFF (except for any 24 Hour Zones).

**Q What happens if the power is turned off?**

A If the mains power is turned off your SUPA8 will continue to operate on its own internal battery for many hours and will indicate the fact by turning on the AC Fail light. When the power is again turned on the internal battery will begin recharging. Your SUPA8 may be programmed to report the power failure and also report when the power is reinstated.

**Q When does the system use my telephone?**

A If your SUPA8 is programmed to report openings and closings, (every time you arm the SUPA8 in AWAY mode and when you disarm it), the SUPA8 will report to the monitoring station. However, it will only report an opening or closing after the appropriate entry or exit delay has expired. The SUPA8 will also use your telephone if you have an alarm which is to be reported, if the mains power fails, or if the back-up battery runs low. While the SUPA8 is using the telephone line the “On-Line” light will be on and the telephone handset that uses that line will be disconnected for the duration of the call.

**Q What happens if the SUPA8 answers the telephone before I get to it?**

A Your SUPA8 may be programmed to answer the telephone after 15 rings. If it answers the call after 15 rings, and before you can get to the telephone, it will automatically hang-up after 30 seconds if it does not hear any tones.

**Q How can I tell if I’ve had an alarm?**

A If an alarm has occurred on a Zone, the respective Zone light on the keypad will be flashing until the SUPA8 is turned OFF. Use the REVIEW mode to view past Zone alarms.

If programmed, the strobe light flashes continuously until the SUPA8 is turned OFF.

**Q There's been a false alarm in the Zone that's been programmed for 24-hour monitoring and I need to reset the SUPA8. What do I do?**

A Turn the system OFF using your User code and the **[0]** key. Then, enter your Master User Code and press **[7]** followed by **[2][5][4]**. This will cause the SUPA8 to reset and disable any 24 hour Zones until it is turned ON again.

## Questions about Using the Telephone

**Q What happens if I get cut off before 15 rings?**

A Sometimes the network will cut short the attempted phone call before 15 rings. This is especially true if making the call from a mobile telephone. If this happens immediately hang up and try again. The SUPA8 will "remember" the last number of rings for 45 seconds so that if only 10 rings were recorded at the first attempt, only 15 - 10 = 5 rings are required on the second phone call, as long as the phone starts ringing within 45 seconds of the first call.

**Q How can I tell if the SUPA8 is OFF?**

A When the SUPA8 first answers the phone a single beep will be heard if the SUPA8 is OFF and two beeps will be heard if the SUPA8 is on in either HOME mode or AWAY mode.

**Q How safe am I from unauthorised use?**

A There are 3 levels of protection. The first level is your User code, which should never be given to anyone. At the second level - when the SUPA8 answers the phone, and if no tone is heard for 30 seconds, the SUPA8 will hang up. Finally, if a tone is heard by the SUPA8 only 4 attempts are allowed to enter a legal code, after which the SUPA8 will hang up. With 2 User codes, thousands of phone calls would have to be made to guess the correct code.

**Q What happens if an alarm occurs whilst I am on the phone?**

A If the SUPA8 needs to use the telephone because an alarm has occurred, or because an opening or closing report needs to be sent, the SUPA8 will immediately terminate your call and wait for 5 seconds before dialling the monitoring station. If you hear the SUPA8 attempting to dial the monitoring station, you should hang up immediately and try again 5 minutes later if required.

## System Record Sheet

Installer:	Phone:
------------	--------

Monitoring company:			Phone:		
Entry Delay	Exit Delay	Siren time	Date installed		

Zone	Description	Siren	Strobe	Delay	Dialler	24hr	Home	Away
1								
2								
3								
4								
5								
6								
7								
8								

Code	Address	Name of codeholder:
User 0 (Master Code)	000	
User 1 (Installer Code)	004	
User 2	008	
User 3	012	
User 4	016	
User 5	020	
User 6	024	
User 7	028	
User 8	032	
User 9	036	
User 10	040	
User 11	044	
User 12	048	
User 13	052	
User 14	056	
User 15	060	